

Haier



Ultra Low Temperature (ULT) Freezer User Manual

Model

DW-86L338J
DW-86L388J
DW-86L490J
DW-86L578J
DW-86L728J
DW-86L828J

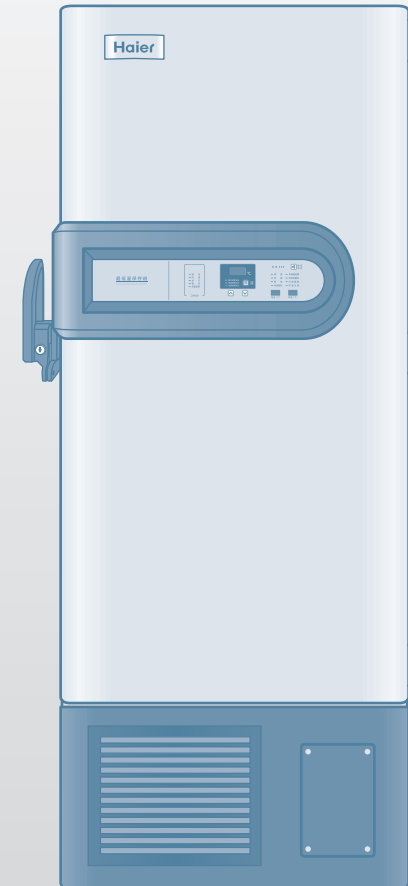

Certificate of Quality

Checker:

Haier Medical and Laboratory Products Co., Ltd.

Address: Haier Industrial Park, Economic
Technology Development Zone,
Qingdao, China

Web: www.haiermedical.com

Version: 1st , 2016

Dedicated code:0270500680A

Manufacturer code:V13026

Read this manual carefully before using the ULT freezer.
Place this manual in a convenient location for future reference.
Translation of the original instruction

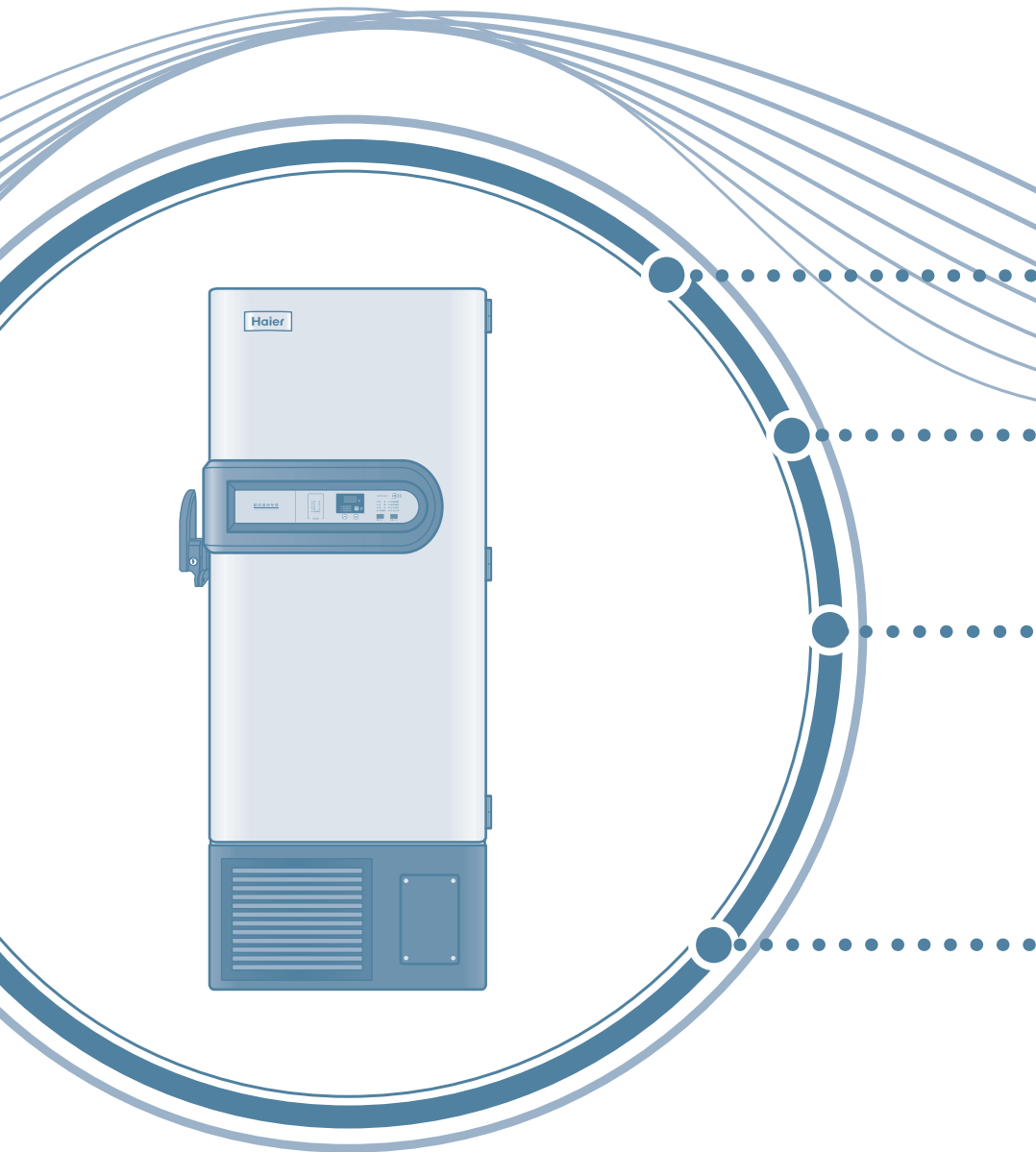

Technical Data

Model	Net volume (L)	Rated voltage (VAC)	Rated frequency (Hz)	Rated current (A)	Weight (kg)	Dimensions (W x D x H) (mm)
DW-86L338J	338	220-240~	50	7.5A	238	812×893×1846
DW-86L388J	388	220-240~	50	8A	255	812×893×1980
DW-86L490J	490	220-240~	50	8A	295	860×900×1980
DW-86L578J	578	220-240~	50	9A	300	895×980×1960
DW-86L728J	728	220-240~	50	10A	345	1041×980×1980
DW-86L828J	828	220-240~	50	10A	380	1145×980×1980

Packing List

Amount	Name	User Manual	Instruction to Install Set Bolts	Plastic bag	Ice scraper	Key	Set bolt
Model							
DW-86L338J		1	1	1	1	4	2
DW-86L388J		1	1	1	1	4	2
DW-86L490J		1	1	1	1	8	2
DW-86L578J		1	1	1	1	4	2
DW-86L728J		1	1	1	1	4	2
DW-86L828J		1	1	1	1	4	2

Haier quality, it merits your trust from beginning to end.

This Product is suitable for the ultra low temperature storage of products in applications such as clinical, pharmaceutical, scientific research, and epidemic institutions. It also can be used in blood stations, hospitals, centers for disease prevention and control, science and research institutions, electronic and chemical laboratories, biomedical engineering institutions, and open sea fishery companies to store red blood cells, white blood cells, viruses, germs, skin, bones, bacteria, sperm, biological products, electronic components, and low temperature testing samples of special products, etc.

Temperature Control

Temperature is controlled by computer and numerically displayed, and regulated in units of 1°C; temperature range: -40°C to -86°C.

Security System

- Various malfunction alarms (high temperature alarm, power failure alarm, probe failure alarm, hot condensor alarm, high ambient temperature alarm, doors open alarm, low battery alarm).
- Two types of alarms (buzzer sounding alarm, flashing light alarm).
- Multiple protection functions (password protection, power up delay protection).
- All independent components are safely grounded.

Refrigeration System

- Optimized multiple refrigeration technology with top brand compressors offering better refrigeration capability.
- Excellent temperature preservation layer providing optimal temperature preservation effect.
- Exclusive sealing structure of multiple doors and hot tubing for condensation prevention can reduce the frost effectively.
- Specially designed low temperature computer control, to prevent the normal redundant systems from being erroneously controlled by the low temperature compressor.

User-friendly Design

- Equipped with LED display which can show the inner temperature, set temperature, ambient temperature and input voltage. And the display can be used to set the high/low temperature alarm and inner temperature, and it also can show any malfunction alarms.
- Designed with adjustable shelves, suitable for product storage.
- Safe lock design prevents accidental opening of doors.
- Broad ambient temperature range design, suitable for usage in 10 to 32°C environments.
- "Innovative" design with integrated door locks and compact leveling legs, which are flexible and convenient.
- Automatically open and close condensation fan to save energy.
- Equipped with networks, remote alarm functions which are advanced and practical.
- USB standard

Because of the continuous improvement of products, your Haier ULT freezer may be different from the ones illustrated in this manual, and we do apologize for this. User manuals are subject to change without notice.

Product Features	1
Contents	2
Safety Labels and Safety Precautions.....	3
Usage Precautions	8
Installation	9
Installation Environment.....	9
Installation Location.....	10
Before Use Preparations.....	11
Initially Powering Up.....	12
Operation after a Power Outage	13
Freezer Parts and Control Panels	14
How to Use the Freezer.....	16
Unlocking the freezer	16
Setting the inner temperature.....	16
Setting the high temperature alarm.....	16
Setting the low temperature alarm	17
Setting the security code.....	17
Setting the start up delay timer.....	17
Alarm test and low battery test.....	18
Setting the USB storage time.....	18
Exporting USB data.....	19
Display and Alarms.....	20
Cleaning and Maintenance.....	23
Recycling the Rechargeable Battery	25
Optional Accessories.....	26
Troubleshooting.....	28
Refrigeration and Wiring Diagram	29
Specifications, Technical data and Packing list.....	31

Warning:

Class A equipment is intended for use in an industrial environment. In the documentation for the user, a statement shall be included drawing attention to the fact that there may be potential difficulties in ensuring electromagnetic compatibility in other environments, due to conducted as well as radiated disturbances.

Specifications

Product name	Ultra Low Temperature Freezer
Model	DW-86L338J/DW-86L388J/DW-86L490J DW-86L578J/ DW-86L728J/DW-86L828J
Exterior/interior wall material	Coated cold rolled steel
Outer doors	Coated cold rolled steel
Inner doors	Aluminum framed PS board
Shelves	Stainless shelves(height adjustable)
Porthole for testing	2
Insulation	Vacuum insulated with polyurethane foam (non-CFC)
Compressors	High stage: hermetically sealed Low stage: hermetically sealed
Evaporator	Copper tube
Condenser	Finned coil
Refrigerant	R290 R170
Temperature controller	Microprocessor controller
Temperature display	Digital display
Temperature sensor	RTD (Pt100)
Alarm device	High/low temperature alarm, probe failure alarm, hot condenser alarm, ambient temperature alarm, low battery alarm , Door open alarm
Battery of remote alarm terminals	Maximum load: 30 V DC, 2 A Rechargeable battery: 12 V DC, charges automatically
Electric shock protection type	I
Power supply connection type	Y
Ambient temperature	10 to 32
Freezer temperature	-40 to -86
Foaming Cabinet	CP/IP
USB	Standard

Wiring Diagram

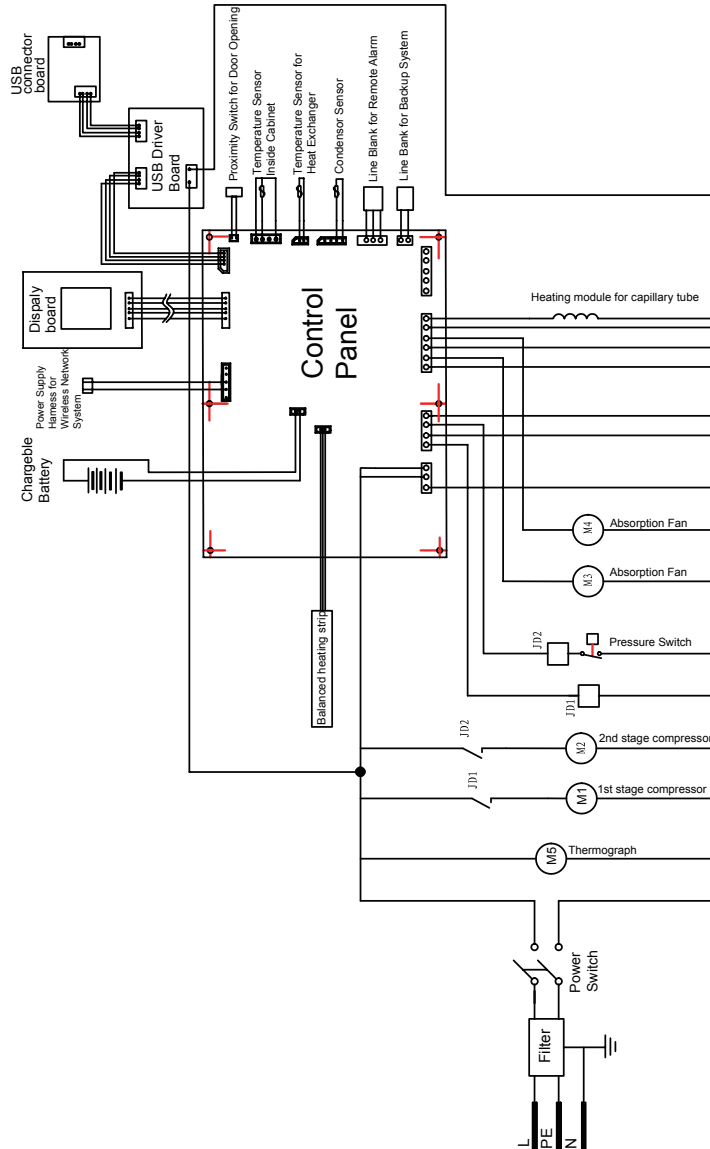

Dear Haier customers,

Thanks for buying a Haier ULT Freezer, to make better use of this manual and this product in order to prevent injuries to personnel and damage to the product, please read carefully and follow the descriptions marked with the following labels.

Safety Labels



Warning



Electricity



Crushing of hands



Hot surface



Low temperature



R170



R290



The upper and lower limits of temperature shall be indicated adjacent to the upper and lower horizontal lines.



Symbol for "Manufacture"



Symbol for "Consult instructions for use"



Symbol for "Date of manufacture"



European Authorized Representative

Haier Biomedical UK

Email: uksales@haierbiomedical.com

TEL: +44(0) 1825 744 696

When power to the unit is on, switch on the battery charger. When the unit is not in use switch power off and then switch off the battery charger..

Charge battery switch

NOTICE!

- Freezer must be placed at least 200mm away from the wall to allow maximum air circulation.
- Changing of Refrigerants should be done according to the Service Manual.

NOTICE!

For the most efficient energy consumption and optimized compressor life, the temperature should be set at the highest temperature suitable for the sample to be stored, normally set at -40°C to -80°C.



Wear Cryogloves before opening the door.



No sitting



Grounding mark



Complied with the requirements of MDD 93/42/EEC annex V

Safety Precautions

Warning Ignoring this warning may result in death or serious injury.

Caution Ignoring this warning may result in death or serious injury, and/or damage to the freezer and property.

Prohibited Actions or operations which are prohibited

Required Actions or operations which must be followed

Warning

- ❗ When a CO₂/LN₂ backup system is activated, the installation place must be well ventilated. Increased CO₂ in the air may be harmful and even fatal. If the ventilation is poor, other methods should be considered in order to ensure safe working environments.
- ❗ If there is a leakage of petroleum gas or other flammable gas, close the gas supply valve and open doors and windows to ventilate the air. Do not plug or unplug your freezer unit in order to avoid potential explosion or fire.
- ❗ Only professional technicians or Haier service personnel can install the unit. Failure to do so may cause electricity or fire.
- ❗ The freezer must be securely installed on a firm floor. Tilted installation may result in the product tipping over thereby causing injury and damage.
- ❗ Please use the dedicated power supply marked on the product label to avoid fire and electric shock.
- ❗ If the voltage being used is 10% higher than the rated voltage, a regulator with a capacity of 4000 W or higher must be installed.
- ❗ If the power cord needs to be extended, the cross-section of the extended cable must be no less than 2 mm² and no longer than 3 m for products of 220V ~ 240V/50Hz or 220V ~ /60Hz and no less than 3 mm² and no longer than 3 m for products of 115V ~ /60Hz to avoid fire or electric shock.
- ❗ Your Haier ULT unit is equipped with a standard three-prong power plug (grounded) complying with the standard three-prong socket (grounded) rated 16 A (220V ~ 240V/50Hz or 220V ~ /60Hz) or rated 20A (115V ~ /60Hz). Removal of the ground prong is strictly prohibited for safety reasons under any circumstances. The electrical power plug should be securely plugged into the socket. A loose plug in the socket may cause fire.
- ❗ The power socket intended for your Haier ULT usage must be grounded to avoid electric shock. If the socket does not meet this requirement, the condition must be corrected by a qualified technician before using the ULT unit.
- ❗ The replacement of any spare parts (battery etc.) shall be conducted by technicians approved by manufacturer.



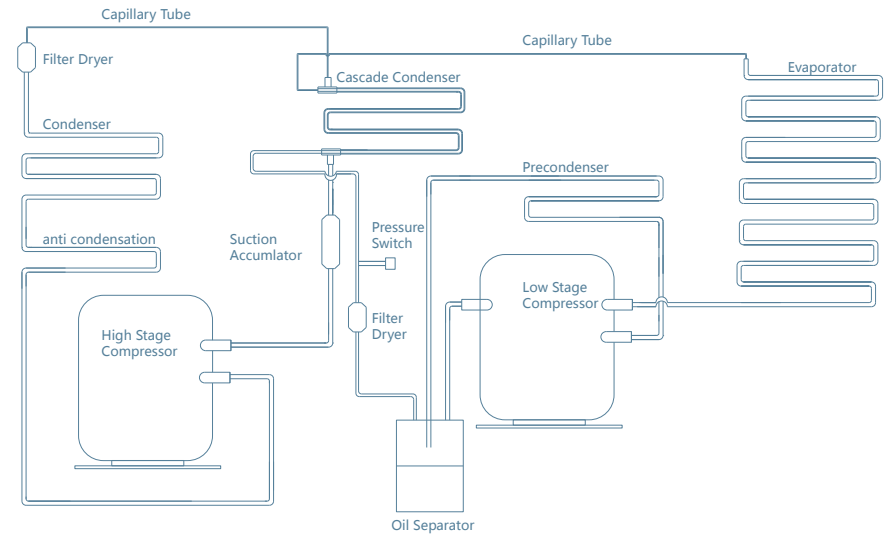













Refrigeration diagram





Should there be any malfunctions in the system, please attempt to answer the following questions before notifying maintenance or calling an Haier Equipment & Instrument Service Center. Please do not dismantle the freezer yourself.

Malfunction phenomenon	Malfunction checks and resolutions
Freezer does not start up.	Is the power supply normal? Has the main power switch been turned on yet?
	Is the voltage supply too low?
	Is there any voltage input from the outside?
Poor refrigeration effect.	Is the ambient temperature too high?
	Are the inner doors and outer doors closed properly? (Has any ice or frost damaged the seals between the door and the frame?)
	Is the condenser filter clogged?
	Is the temperature setting correct?
	Is the freezer being kept away from direct exposure to sunlight?
	Is the freezer near any heat source?
	Is the porthole plug installed in the porthole with proper insulation materials?
	Has the freezer been loaded with too many non-frozen samples within the last few hours?
The unit is noisy.	Is the unit set on a firm and level floor?
	Is the exterior of the unit touching any objects?
	Is the freezer unit leveled with the leveling legs?

-  Never install your ULT in an unprotected area. If the unit is rained on, there is a danger of electric shock.
-  Your Haier ULT must not be installed in a damp area or an area subjected to water spray. Otherwise this may reduce the degree of insulation and thereby cause electrical leakage or electrical shock.
-  Never directly pour water into the unit. The water may cause electric shock or short circuit.
-  Do not place any water container or heavy object on top of the unit. A falling object may injure an operator. If the water spills into the unit, it may damage the insulation thereby causing electric shock.
-  Never use gas lines, water mains, telephone lines or lightning rods as the grounding device for your Haier ULT unit. This type of improper grounding may cause electric shock or other danger.
-  Do not touch any electrical components, switches or power cord with wet hands. Such action may lead to electric shock.
-  When unplugging the power cord from the socket, please grip the plug itself and pull it out. Do not pull the power cord as this may strip the wires out of the plug thereby causing electric shock and fire.
-  Should there be any malfunction in the equipment, power off the unit and unplug the power cord from the power supply. Continuous operation in an abnormal condition may result in electric shock and fire.
-  Users must not dismantle, repair or modify the equipment. Such improper operations may result in fire or personal injury.
-  Before any repair and maintenance of the freezer, please disconnect the power to avoid electric shock or injury to personnel.
-  When repairing and maintaining your freezer, take precautions not to inhale any chemicals or aerosols floating inside and outside the unit. They might be harmful to your health.
-  If poisonous, radioactive or other harmful materials need to be stored in the unit, the equipment should be located in a safe zone. Improper usage of the equipment with such materials may harm the environment or operator's health.
-  If the unit is not in use for a long period of time, make sure the power cord is unplugged. Deteriorated insulation of the power cord may lead to electric shock or fire.
-  If the freezer is not in use in an area without any supervision, please make sure children will not approach the freezer and the doors should not be closed.
-  The wastes of the freezer need to be disposed by specialized personnel, no arbitrary movement of it is allowed; or otherwise, events of kids being shut in it may occur.
-  Do not use any non manufacturer-approved electrical components in the freezer.

- ⊘ Never store flammable, explosive or volatile materials in the unit and do not use any flammable spray near the unit, as this may cause an explosion or fire.
- ⊘ Never store corrosive chemicals with acid or alkaline properties in the unit as this can lead to damage to internal components of the unit.
- ⊘ Do not place any glass container or enclosed container into the freezer. These containers may crack at low temperatures causing injury to operators.
- ⊘ Plastic bags should be placed where children cannot reach them, because such bags could cause asphyxiation.
- ⊘ Do not climb on top of the unit or place any object on it. Falling equipment may cause injury or property damage.
- ⊘ Do not use any hard objects such as nails and wires to explore any openings or gaps such as air ventilation ports. Accidental contact between a hard object and a moving part may result in electric shock or injury.
- ⊘ Do not use electrical appliances inside the food storage compartments of the appliance unless they are of the type recommended by the manufacturer.
- ⚠ The appliance must be positioned so that the plug is accessible.
- ⚠ The appliance must be placed on a solid and flat surface, or excessive vibration and noise may be produced when the appliance is in operation.
- ⚠ If your cabinet is to be discarded, you must remove the door and leave the shelves in place. This will reduce the possibility of danger to children. And the flammable foaming needs to be disposed by professional persons.
- ⚠ This appliance can be used by children aged from 8 years and above and persons with reduced physical, sensory or mental capabilities or lack of experience and knowledge if they have been given supervision or instruction concerning use of the appliance in a safe way and understand the hazards involved. Children shall not play with the appliance. Cleaning and user maintenance shall not be made by children without supervision.
- ⚠ If the supply cord is damaged, it must be replaced by the manufacturer, its service agent or similarly qualified persons in order to avoid a hazard.
- ⊘ Users must not dismantle, repair or modify the equipment. Such improper operations may result in fire or personal injury.
- ⚠ CP/IP foaming materials are flammable, need professional processing.
- ⚠ No modification of this equipment is allowed
- ⚠ To avoid the risk of electric shock, this equipment must only be connected to a supply mains with protective earth.
- ⚠ There should be at least 30 cm space between the surrounding walls and the freezer for ventilation.
- ⚠ Equipment can not run in the condition of rich O₂ and flammable gas or liquid.

Storage racks and boxes

If the unit is used to store small samples, storage racks and boxes provide more efficient use of internal space.

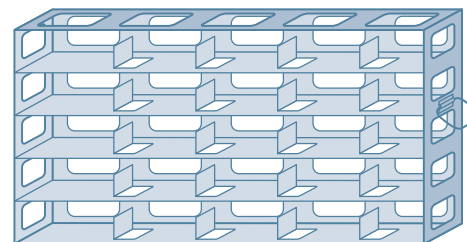

Type A storage racks (side open model)

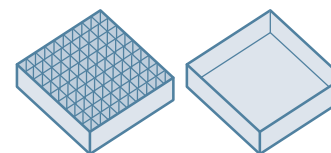

Storage box

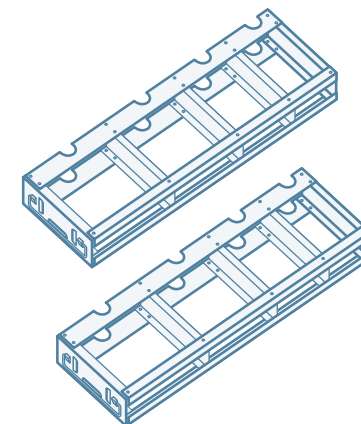

Type B storage racks (drawer model)

Model	Storage Rack (Type A/B are available)		Storage Box
	ariety	Amount	Amount
DW-86L338J	4 × 4	6	96
	5 × 4	6	120
DW-86L388J	5 × 4	12	240
DW-86L490J	4 × 4	8	128
	5 × 4	8	160
DW-86L578J	5 × 5	16	400
DW-86L728J	5 × 5	20	500
DW-86L828J	5 × 5	24	600

Note: The storage racks and boxes may differ from the illustrations.

Temperature recorder

When using the temperature recorder, please refer to the "User manual for Temperature Recorder" provided with the recorder.

 **Caution** The temperature recorder should only be installed by professionals or Haier serviceman.

 **Warning** Before installing the temperature recorder, please cut off the power supply to avoid electric shock or fire.

CO₂ and LN₂ backup cooling system

For installation and operation of the backup cooling system, please refer to the user's manual provided with the system.

















If the free-standing back up system is to be connected to DW-86L490J, it's necessary to buy the relative switch box and plate.

 **Caution** Please purchase steel cylinders fitted with a siphon, the siphon can be used to siphon up fluids that flow out from the bottom of the steel cylinders.

 **Warning**

- The installation place of any equipment using CO₂/LN₂ must be in a well ventilated area. Increased CO₂ in the air may be harmful and even fatal. If the ventilation is poor, another method should be considered in order to ensure a safe working environment.
- If a CO₂ / LN₂ steel cylinder falls over or one of the valves is damaged, then the steel cylinder will be turned into an uncontrollable lethal projectile.
- The temperature of liquid CO₂/LN₂ is extremely low, which could cause frostbite. When replacing the cylinder, please always wear a pair of protective glasses and protective clothes.

Caution

-  After restarting your unit from a power outage or shutdown, ensure that all settings are correct. Accidental changes in settings may damage the stored products.
-  In the event of a power outage and recovery, be sure to wait for at least 5 minutes before turning the unit on again to avoid damage to the compressors and refrigeration system.
-  The air filter for the condenser should be cleaned regularly. A dirty filter could cause a malfunction or the freezer temperature to rise.
-  During any repair operations, gloves should be worn to prevent getting injured by sharp edges or corners.
-  Do not use bare hands to directly handle any stored products. The cold temperature of the products and the interior walls may cause frostbite.
-  Hold firmly onto the handle to close the door to avoid pinching your hands.
-  Do not tilt the unit more than 45 degrees when moving the unit.
-  When moving the unit, please be careful not to stumble with the unit which could cause injury to personnel and damage to the unit.
-  Do not attempt to use the handle to lift or move the unit to avoid damaging the freezer or injuring personnel.
-  Please open the lock first, then lift the handle.
-  Maximum loading on the each shelf should be no more than 50 kg and total loading for whole unit should be no more than 200 kg. Heavier loads may cause damage to the shelving system.
-  Keep ventilation openings , in the appliance enclosure or in the built-in structure, clear of obstructions.
-  Do not use mechanical devices or other means to accelerate the defrosting process, other than those recommended but the manufacturer.
-  Do not damage the refrigerant circuit.
-  Unauthorized opening of the top cover of the control cabinet is prohibited in order to prevent damage to the inside components or injury to the operator.
-  Turn the battery switch on before starting the unit, do not arbitrarily turn it off.
-  When the ULT unit has been placed in a storage or not in use for a long time, its battery should be tested for low capacity because the battery may have already released all of its energy. Should this occur, please turn on the battery switch and run the unit for about a week to fully charge up the battery.

- When the unit operates normally, the unit frame at the front near the door may be slightly warm. This phenomenon is normal because hot tubing is embedded there to prevent condensation from forming on the frame.
- Before samples are loaded into the unit, make sure the unit temperature has reached the set point then load the samples into the freezer in batches. Each batch should not exceed 1/3 of the unit capacity so that the temperature does not rise while samples are being loaded.
- The temperature display indicates the temperature where the temperature sensor is mounted inside the unit chamber, which may vary from the temperature at the center of the freezer, but it will gradually reach the actual temperature of the freezer over time.
- Two access port is installed in the back wall of the unit which can be used as the through hole for the thermocouple wires during testing and validation. After all test wires are let through the access port, make sure that the gap in the port is sealed properly with insulation materials. Otherwise, the unit temperature may not come down to the desired temperature. The port ring in the outer wall can also accumulate frost and ice.
- When cleaning the unit, mild or neutral detergent solution should be used. Never use a hard wire brush, acid, gasoline, detergent powder, polishing powder, or hot water to clean the freezer as these tools and materials can damage the paint coating and plastic components. Particularly, never use gasoline or a solution with volatile chemicals to clean plastic or rubber parts.
- After the freezer runs for some time, a layer of frost usually forms on the interior liner and inner doors. When this layer of frost get too thick, it can negatively impact the refrigeration performance of the unit. Energy consumption can increase. If the thickness reaches about 5 mm, please use the supplied scraper to remove the frost.
- Before removing the frost, temporarily transfer the stored samples to another freezer. This is so that the temperature does not rise in the unit and damage the samples.
- Behind the interior walls, there are many refrigeration tubes. Do not use a knife, an ice pick, or a screwdriver to cut ice and frost. This may damage not only the liner but also the refrigeration tubes.
- If the freezer is not in use for a long time, please turn off the power and switch off the backup battery. The power cord should be unplugged.

The Haier freezer is equipped with a rechargeable battery. This battery is recyclable. When the battery reaches the end of its life, please contact a local recycling organization for inspection or properly discard the battery.

Location of the battery

The battery in the electric cabinet is for the power outage alarm. It is located inside the control corner of the right side of the unit.

⚠ There are high voltage components in the control box. To prevent electric shock, only a qualified technician or engineer can open the cover.

Removal of the battery

1. Turn off the power of the unit and unplug the power cord from the socket.
2. Use a screwdriver to remove the screws on the side panel and take down the side panel.
3. Use a screwdriver to remove the 4 screws on the cover of the control box.
4. Unplug the connecting terminals from the battery.
5. Remove the bracket that fastens the battery. Remove the battery.
6. Follow regulations to recycle the battery or discard it properly.

⊘ When changing the battery, you must make sure that the brown wire connects to the positive pole of the battery, and the blue wire connects to the negative pole of the battery. The polarity must not be reversed. Incorrect polarity can damage the computer's motherboard so that it cannot charge the battery.

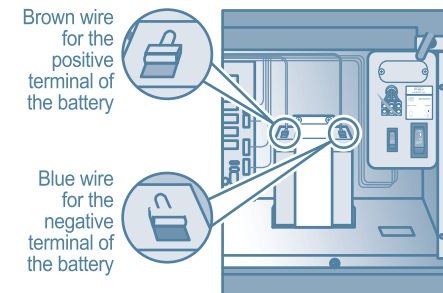

Defrost the interior

Frost and ice can form in between the door gasket and frame to form an air gap, which can decrease the refrigeration effect of the unit. Please use the provided plastic scraper to defrost the interior doors.

The following steps are how to defrost.

1. Turn off any backup refrigeration system if there is one.
2. Remove the samples from the unit that needs to be defrosted. Move them to another unit or a container for temporary storage.
3. Turn off the power supply.
4. Open the outer door and inner doors to let the unit thaw for a period of time.
5. Use a dry cloth to soak up and remove any water on the floor of the unit.
6. After defrosting the unit and cleaning up the water, restart the unit.
7. Load the samples back into the unit after it reaches the set temperature.
8. Turn on the backup refrigeration system if there is one.



Caution

Do not use any sharp tools such as knives or screwdrivers to defrost.

Battery maintenance

- If the battery capacity is low, please make sure the battery switch is turned on, and the battery will be charged. After about one week of charging, please recheck the battery capacity. If normal, the battery should be in full capacity. However, if the capacity is still low, please change the battery.
- The battery that supports the power outage alarm is a consumable item. The life expectancy for the battery is 2 to 3 years. If the battery is more than 3 years old, the battery should be replaced because the alarm function may not work properly. To do so, please contact an Haier Equipment and Instrument Service Center

Disposal of the freezer



Warning

- If the freezer is not in use in an area without any supervision, please make sure children will not approach the freezer and the doors should not be closed.
- Disposal of the freezer should be carried out by professionals. When disposing, please remove the doors to prevent accidents such as asphyxiation from occurring.

Installation Environment

- Ambient temperature: 10°C to 32°C .The ideal temperature is 18°Cto 25°C. If necessary, use an air-conditioning system to achieve the required ambient condition.
- Environment humidity: less than 80%RH. At an environment of 32°C, humidity should be less than 57% RH.
- The intended location should be low in dust count.
- The intended location should be vibration and shock free.
- The highest elevation the unit can work safely: 2,000 m above sea level.
- Input voltage: within 220 V± 10%.



Caution

- An ULT freezer is usually sensitive to its operating environment. If a unit is not installed in the conditions mentioned above, it cannot operate reliably. Please improve the environmental conditions before using the equipment.
- It is prohibited to use the unit in an outdoor place. After the unit is rained on, there is a danger of electric shock.



Meaning of crossed out wheeled dustbin:

Do not dispose of electrical appliances as unsorted municipal waste, use separate collection facilities. Contact you local government for information regarding the collectionsystems available.If electrical appliances are disposed of in landfills or dumps, hazardous substances can leak into the groundwater and get into the food chain, damaging your health and well-being. When replacing old appliances with new ones, the retailer is legally obligated to take back your old appliance for disposals at least free of charge.

Installation Location

For the equipment to achieve optimal operating conditions, an intended installation location should satisfy the following requirements.

- Do not install the unit in a confined place. The doorway should be large enough for the unit to freely enter or exit the room if necessary. This is to allow the unit to be repaired easily and timely to avoid damage to property.
- The location for installation should be flat and firm.
- There should be good ventilation and no direct sunlight.
- The freezer unit cannot share the same power socket with other equipment. The power plug should be securely connected with the power socket.
- The power cord for the freezer should not be twisted or pinched.
- If the power cord needs to be extended, the cross-section of the extended cable must be no less than 2 mm² and no longer than 3 m.
- Before using the freezer, check the voltage supply. A voltage stabilizer to deliver 220 V ±10% is recommended for areas where the voltage is known to be unstable. The voltage stabilizer should be rated at least 4000W .
- The freezer must be securely grounded.
- If the power socket is connected with a ground terminal, make sure to inspect it for proper connection before using the equipment.
- If the socket is not grounded, it must be connected to a grounded terminal by a qualified technician.



- Do not ground the freezer through gas lines, water mains, telephone lines and lightning rods as this may lead to electric shock.
- After installation, the power plug must be easy to reach. In case of emergency, it is easy to unplug. Nothing should block the ventilation port of the freezer.

Cleaning Freezer Parts



- To prevent electric shock or injury to operators, the AC power supply to the freezer must be disconnected completely before any repair and maintenance work is to be performed.
- During any repair maintenance work, do not inhale medical particles or aerosols near the equipment as they might be harmful to your health.

Cleaning the freezer

- Clean the unit once a month. This can help the exterior look new.
- Use a dry cloth to wipe away loose dust inside and outside of the freezer. If the unit is rather dirty, use a clean cloth soaked with a neutral detergent to clean the unit. Then use a dry cloth to wipe away any residual detergent solution.
- Do not pour water directly onto the exterior or into the interior of the unit. Water can damage the electrical insulation thereby causing a malfunction.
- Compressors and other mechanical parts are hermetically sealed. They do not need lubrication.
- Clean the frost and ice off the unit once a month. Also, clean the condenser filter once a month.

Clean the condenser filter

When the control panel shows an alarm signal for "Hot Condenser", the alarm light flashes. Even if the light is not on, the filter should still be cleaned once a month. If the filter is clogged, it will affect the refrigeration efficiency and reduce the product's life-span.

To clean the filter, follow the procedure below.

1. Pull off the front grill cover.
2. Pull out the filter screen.
3. Use water to wash the filter screen.
4. After the filter screen is dry, reinstall it back in its original position and close the cover.
5. If the "Hot Condenser" light is on before cleaning, check the light to make sure that it shuts off after cleaning. If it does not shut off, please contact after-sales service personnel.

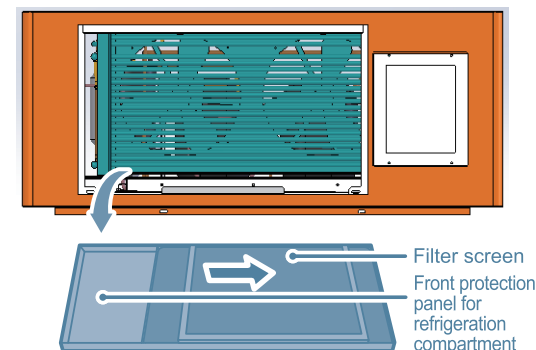

Caution

- A flashing alarm cannot be cancelled unless the malfunction is eliminated. The buzzing alarm can be temporarily silenced for 30 minutes by pressing the "Silence" key. However, if the problem is not fixed, the buzzer alarm will resume after 30 minutes.
- When using the freezer, the battery switch must be turned on to charge the battery.
- When there is a power outage, the battery sustains the temperature display. If the battery voltage is insufficient, the temperature display will turn off.
- While the battery is still capable of providing power to the display, the temperature display can be turned off by unplugging the power cord and turning off the battery control switch.
- The freezer is also designed to auto-adjust the inner temperature set point in high ambient temperatures. When the ambient temperature is warmer than 35°C and the set point temperature is set to be lower than -82°C, the set point temperature will automatically default to -82°C. If the ambient temperature is equal to or cooler than 30°C, the set point will resume at the intended inner set point. This feature extends the life expectancy of the freezer.

Setting the buzzer alarm resumption time

- When the unit is in the alarm mode, you may press the "Silence" key to stop the buzzing of the alarm. (The remote alarm cannot be cancelled)
- If the alarm condition still persists, the buzzer alarm will resume automatically after 30 minutes.

Remote alarm terminals

- Remote alarm terminals are located on the control box on the right side of the unit. The alarm signals are delivered via the terminals. The terminals are rated for 30V DC at 2A.
- Terminal output:
Remote alarm terminals consists of NC, NO and COM terminals. Users can choose the Normal Open or Normal Close alarms as needed.

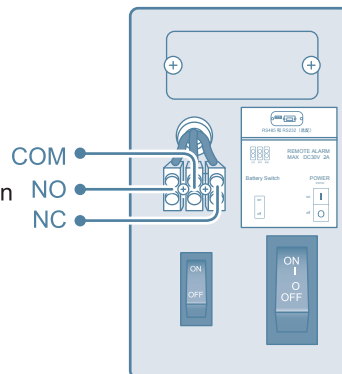

Before Use Preparations

1. Remove packing materials and straps

Remove all packing materials and straps for transportation.

2. Check the supplied accessories

Check the items in the packing box according to the packing list. If they do not match each other, please contact Haier immediately.

3. Installation environment

There should be at least 30 cm space between the surrounding walls and the freezer for ventilation.

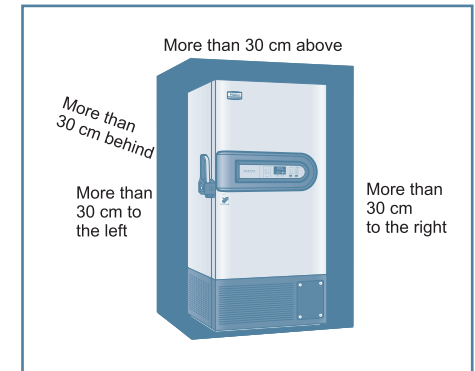

4. Adjust support legs

Rotate the leveling legs clockwise to extend them out to support the unit to the floor to ensure that the unit does not move while in usage.

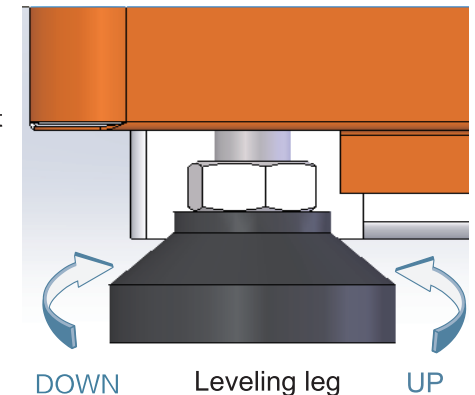

5. Placement

After adjusting and cleaning the unit, do not connect the power cord immediately. The freezer needs to be placed in its intended location for at least 24 hours before connecting the power to make sure it will operate normally.

Initially Powering Up

When the unit is started for the first time, please follow the procedures below.

① While keeping the unit empty, plug in the power cord to a dedicated power socket that meets all requirements.

② Please connect the freezer to the power supply, turn on the power switch located on the right of the freezer (as in the illustration on the right), and then turn on the battery switch.

③ If the unit has a backup cooling system (optional), turn off the backup system.

④ Set the unit to a desired temperature: Do not load the unit with any samples. Power up the unit to let it run down to -60°C . Let it run at -60°C for 8 hours then lower it to -80°C . Observe the unit performance for 24 hours for normal cycling to ensure that it is working properly.

⑤ Once the unit is confirmed to be operating properly, it is ready to be loaded with samples. In principle, the freezer unit should be set at about 3°C above the desired temperature. For example, if the storage temperature is -60°C , set the unit at -57°C . Load the unit with samples in batches of less than 1/3 of the unit's capacity. Make sure that the unit is capable of cycling for more than 8 hours.

⑥ If the unit has a backup cooling system (optional), turn it on.

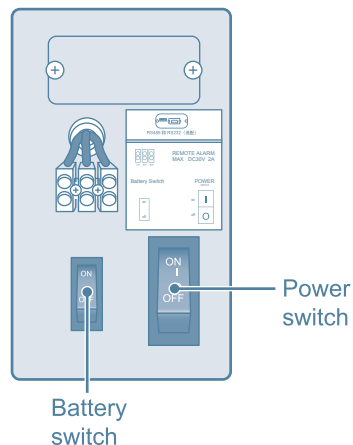

Alarms	Alarm triggering conditions	Indicators	Buzzers
High ambient temperature alarm	Ambient temperature is higher than 32°C and lower than 38°C .	Alarm indicator flashes.	—
	Ambient temperature exceeds 38°C .	Alarm indicator flashes.	Buzzer sounds intermittently.
Probe failure alarm	Main cabinet temperature control sensor fails.	Alarm indicator flashes. Display alternates back and forth between E2 and cabinet temperature.	Buzzer sounds intermittently.
	Condenser sensor fails.	Alarm indicator flashes. Display alternates back and forth between E1 and cabinet temperature.	Buzzer sounds intermittently.
	Ambient temperature sensor fails.	Alarm indicator flashes. Display alternates back and forth between E0 and cabinet temperature.	Buzzer sounds intermittently.
Low battery alarm	Lower battery capacity or battery switch is not turned on.	During the test, the alarm indicator flashes.	—
		Heat exchanger sensor fails.	Alarm indicator flashes. Display alternates back and forth between E3 and cabinet temperature.
Doors open alarm	The door remains open for more than 5 minutes.	Alarm indicator flashes.	Buzzer sounds intermittently.

When the freezer is powered up, and the power switch is turned on, the display will show the inner temperature, ambient temperature and current voltage.

Instructions on the display panel working conditions:

"Locked" indicator on: indicates all settings are locked to prevent erroneous operations.

"Network" indicator on: indicates the network is in working mode.

"Run" indicator on: indicates the compressors are in working mode.

"Regulator" indicator on: indicates the voltage stabilizer is in working mode to increase or decrease the voltage.

"Backup System" indicator on: indicates the backup cooling system is in working mode.

Alarms

Alarms	Alarm triggering conditions	Indicators	Buzzers
High temperature alarm	When this indicator is on, the unit temperature reaches the high temperature alarm limit.	Alarm indicator flashes.	15 min. delay then buzzer sounds intermittently (Note: delay of 3 hours following initial power up)
Low temperature alarm	When this indicator is on, the unit temperature reaches the low temperature alarm limit.		
Power failure alarm	Equipment loses power.	Alarm indicator flashes. Display shows temperature and blinks intermittently.	Buzzer delays 1 minute then sounds intermittently.
Excessive voltage alarm (some models)	Voltage exceeds the high or lower limits.	Alarm indicator flashes.	Buzzer delays 1 minute then sounds intermittently.
Dirty condenser alarm	Condenser filter element is clogged or the ambient temperature is too high.	Alarm indicator flashes.	Buzzer sounds intermittently.



- Your Haier ULT unit should be cared for by dedicated personnel. Every 2 to 4 hours, the unit's working status should be inspected and recorded on a daily basis. Should there be a malfunction in the unit, the freezer temperature rises. If the problems cannot be corrected in a short time, please remove the stored samples; move them to another unit that meets the temperature requirements to avoid potential damage to samples.
- Before putting samples in the freezer to be stored, first check that the freezer's temperature for the samples conforms with the temperature that is required for the samples, in order to prevent the samples to be stored from getting damaged or lost due to the freezer not attaining the temperature required.
- Because it takes time for the refrigeration temperature to reach the stored samples, there is normally a temperature discrepancy between the actual shown temperature and the set point. This is a normal phenomenon. The lower the set point is, the smaller this temperature discrepancy becomes.



- All ultra low temperature storage units are low temperature storage equipment. It is prohibited to load an excessive amount of samples into the unit at one time. The compressors run for a long period of time without stopping. The freezer temperature may not decrease, and the compressors can become overheated. Samples must be loaded in batches, and while incrementally decreasing the temperature setting. The process should be repeated until the final temperature is reached.
- Do not use any unauthorized mechanical tools or other means to accelerate the defrosting process.
- Do not damage the refrigeration circuit.
- Do not use any non manufacturer-approved electrical components in the freezer.

Operation after a Power Outage

Your Haier ULT freezer control setting is stored in its memory system. Should there be a power outage and recovery, the unit can resume its operation based on the previous settings.



- In the event of a power outage and recovery, be sure to wait for at least 5 minutes before turning the unit on again to avoid damaging the compressors and refrigeration system.
- If the unit is not in use for a long period of time, make sure the power cord is unplugged. Deteriorated insulation of the power cord may lead to electric shock or fire.
- If the freezer is not in use in an area without any supervision, please make sure children will not approach the freezer and the doors should not be closed.

Freezer Parts

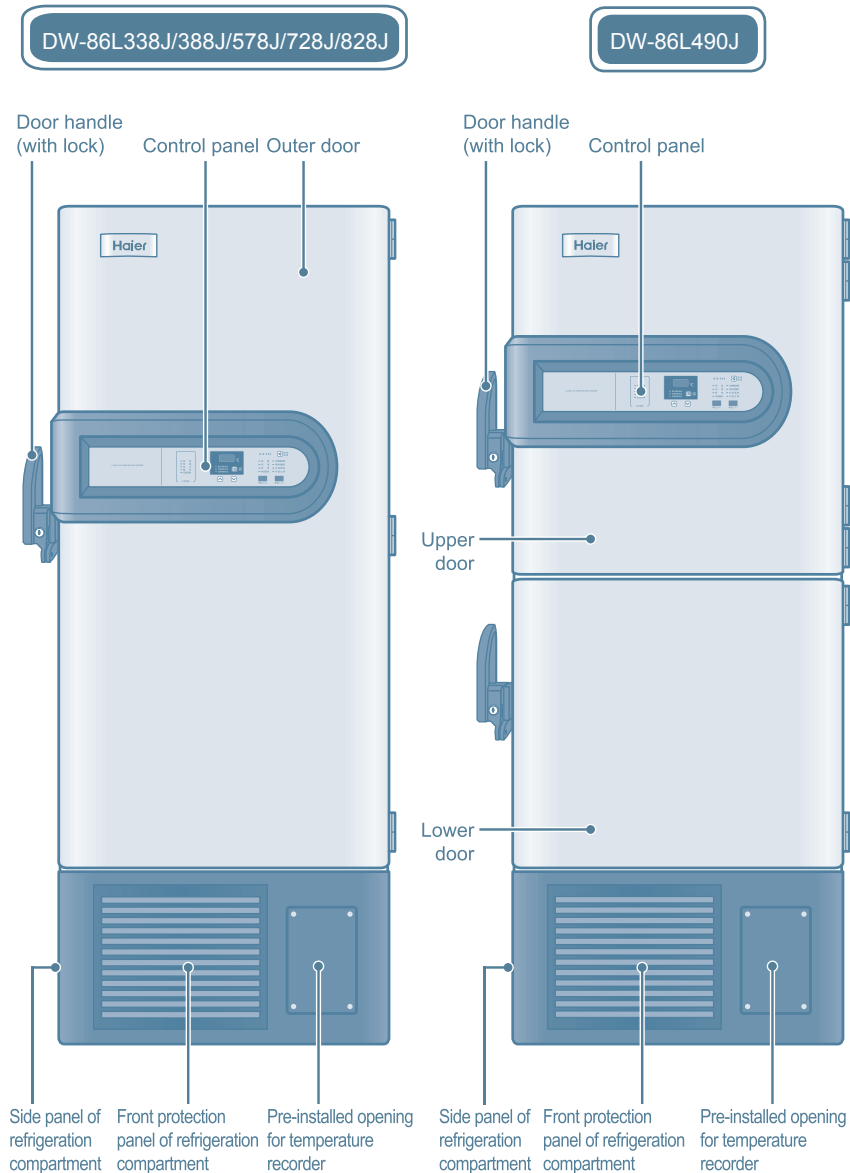

During the above procedure setting 1P to 5P, you can use "↶" or "↷" key to adjust the settings individually.

For example: The temperature display shows 1P (Years), if you do not need to change Years (1P) and Months (2P), you can adjust Days (3P) directly.

1. Press "↶" key to select Days (3P).
2. Press "Set" key, the temperature display shows the date and flashes.
3. Press "↶" or "↷" key to adjust the current date.
4. Press "Set" key to save the change. Then, the temperature display will show Hours (4P).
5. If you need to adjust the Hours, press "Set" key to change the setting. If no adjustments need to be made, press "↶" key, the display shows Minutes (5P), and you can make changes.
6. After having finished the settings, press and hold "Set" for 5 seconds, the changes will be saved and the settings will be automatically exited from. Then, the temperature display will normally show the inner temperature.



During the above procedure setting 1P to 5P, after finishing the adjustment of any of the settings, if no other settings do not need to be changed, you can just press and hold "Set" key for 5 seconds to save the changes and exit the settings.

Exporting USB data

1. In unlocked mode, insert the USB flash drive. The temperature display shows USB, which means data is being exported.
2. When the temperature display shows ALL, exporting of the data is finished, please remove the USB flash drive.

Caution The system memory can save data for 10 years.

Alarm test and low battery test

1. In unlocked mode, simultaneously press and hold "☒" key and "Silence" key for 5 seconds, the buzzer alarm sounds and the alarm indicator flashes.
2. At this time the 6-second battery current test is initially implemented. If the battery capacity is low, the low battery indicator will flash 6 times. If the battery capacity is normal, the indicator will not light up or flash. The choices are from 05 to 30.
3. After 6 seconds, the alarm test starts up. All indicators will light up for 6 seconds without flashing and all electric display windows will indicate "8" for 6 seconds, which means all display functions are working properly.



Setting the USB storage time

1. In unlocked mode, press and hold "☒" key for 3 seconds, the temperature display steadily shows "1P". ("1P/2P/3P/4P/5P" stands for "Years/Months/Days/Hours/Minutes" respectively)
2. Press "Set" key, the temperature display shows years and flashes (default value: 10). Press "☒" or "☑" key, select years. The choices are from 10 to 99. If you want to set the year 2013, select 13. Press "Set" key to save the changes. Then, the temperature display steadily shows "2P". Follow the procedure above to set "2P", "3P", "4P" and "5P" respectively, and press "Set" key to save the changes. Then, the temperature display will show "1P" again, and you can set 1P to 5P again. For example: Set the time as 08:30, Aug. 16, 2013
3. After the settings are completed, press and hold "Set" for 5 seconds, the changes will be saved and exit the settings automatically. Then, the temperature display will normally show the inner temperature.

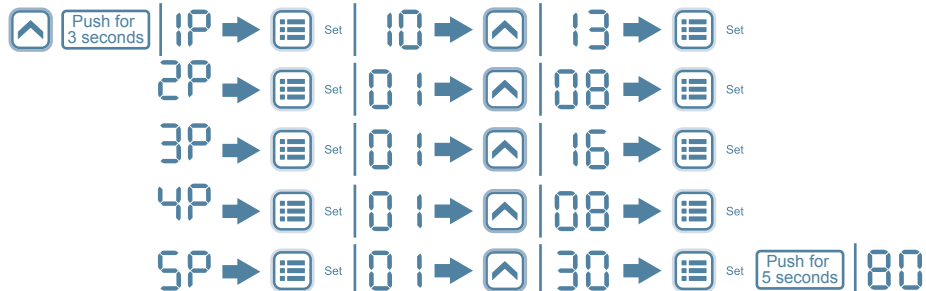

Control Panels

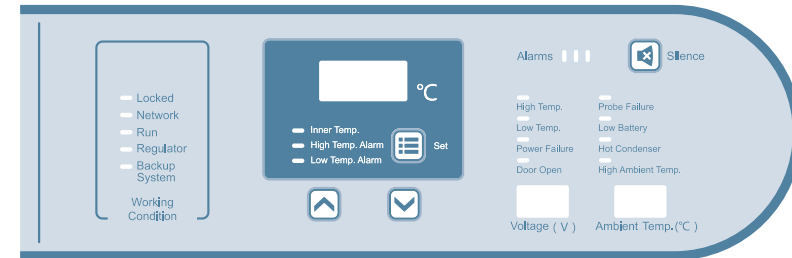

How to Use the Freezer

Unlocking the freezer

Before adjusting the settings, you must unlock the freezer.

1. Press "▲" or "▼" key, adjust the number to "06".
2. Press and hold "Set" key for 5 seconds, the "Locked" indicator turns off. The unit is in unlocked mode, and can be set.
3. Press "Set" key again to select mode for setting the inner temperature, high temperature alarm and low temperature alarm, and the corresponding indicator lights up as each function is selected.



Setting the inner temperature

1. In unlocked mode, press "Set" key to select "Inner Temp.", the temperature display flashes and displays the setting value.
2. Then, press "▲" or "▼" key, adjust the temperature setting value. Temperature setting range: -10 to -86°C. Recommended temperature setting range: -40 to -86°C.
3. After adjustment, do not touch the unit for 10 seconds. The unit automatically enters the locked mode and the temperature display stops flashing which means the value set has been input into computer. Otherwise, the setting is invalid.

For example: Set the inner temperature to -80°C.



4. After setting the inner temperature, the high temperature alarm and low temperature alarm will automatically adjust to proper values accordingly. If users have special requirements, follow the following steps to adjust the values manually.

Setting the high temperature alarm

1. In unlocked mode, press "Set" key to select "High Temp. Alarm", the temperature display flashes and displays the setting value.
2. Then, press "▲" or "▼" key, adjust the high temperature alarm setting value. Temperature setting range: at least +5°C above the inner temperature.
3. After adjusting, do not touch the unit for 10 seconds. The unit automatically enters the locked mode and the temperature display stops flashing which means the value set has been input into the computer. Otherwise, the setting is invalid.

For example: If inner temperature is set to -80°C, setting the high temperature alarm to -75°C is recommended.



Setting the low temperature alarm

1. In unlocked mode, press "Set" key to select "Low Temp. Alarm", the temperature display flashes and displays the setting value.
2. Then, press "▲" or "▼" key, adjust the low temperature alarm setting value. Temperature setting range: above -91°C and at most -5°C above the inner temperature.
3. After adjusting, do not touch the unit for 10 seconds. The unit automatically enters the locked mode and the temperature display stops flashing which means the value set has been input into the computer. Otherwise, the setting is invalid.

For example: Set the low temperature alarm to -91°C.



Setting the security code

When used for the first time, the security code to unlock the control is "06".

1. In unlocked mode, simultaneously press and hold "Set" key and "Silence" key for 5 seconds, the temperature display shows "06".
2. Then, press "▲" or "▼" key, adjust the security code. The choices are from 05 to 30.
3. After adjusting, do not touch the unit for 5 seconds. The unit automatically enters the locked mode which means the setting is valid. (Note: please remember your code.)

For example: Change the security code from 06 to 05.



Setting the start up delay timer

In order to reduce the startup power surge after a power outage, your Haier ULT incorporates a startup delay feature which can alter the startup sequence of the compressors in the freezer.

1. In unlocked mode, simultaneously press and hold "Set" key and "▼" key for 5 seconds, the temperature display shows the factory default value of the time delay "01" (1 minute).
2. Then, press "▲" or "▼" key, adjust the value. The choices are from 01 to 10 (1 to 10 minutes are available.).

For example: Change the time delay from 1 minute to 5 minutes.

